



WOODEN/FRAMED DOOR HARDWARE

Ozone offers a wide range of Tested & Certified Door Control Devices for all types of doors, be it glass, wood, or metal door. Apart from functional performance, every door hardware is designed to meet modern interiors aesthetic needs. With introduction of new Door Closers and Door Handles, the range is further strengthened to be more competent and offer numerous choices to the customers. Explore the range yourself to review the latest additions in the range.

OVERHEAD DOOR CLOSERS



Finish : Silver

E Series



NSK-480E STD SILVER ₹ 1,595

SCREEN DOOR CLOSER

Rack and Pinion Overhead Door Closer with Adjustable closing force EN 1/2

- Maximum door weight: 25-45kg
- Finish: Silver



NSK-580-11 STD SILVER ₹ 2,523

OVERHEAD DOOR CLOSER (Scissors ARM)

Rack and Pinion Overhead Door Closer with Adjustable closing force EN 1/2

- Maximum door weight: 45kg
- Finish: Silver



Tested 500,000
Cycles



45 Kg
Weight Carrying
Capacity

E Series



NSK-580E STD SILVER ₹ 1,910

OVERHEAD DOOR CLOSER (Scissors ARM)

Rack and Pinion Overhead Door Closer with Adjustable closing force EN 1/2

- Maximum door weight: 45kg
- Finish: Silver



45 Kg
Weight Carrying
Capacity

E Series



NSK-640E STD SILVER ₹ 2,663

OVERHEAD DOOR (Scissors ARM)

Rack and Pinion Overhead Door Closer with Adjustable closing force EN 3

- Maximum door weight: 60kg
- Finish: Silver



60 Kg
Weight Carrying
Capacity

OVERHEAD DOOR CLOSERS



NSK-680 STD SILVER ₹ 3,315
OVERHEAD DOOR CLOSER
(Scissors ARM)

Rack and Pinion Overhead Door Closer with Adjustable closing force EN 2-4
• Maximum door weight: 80kg
• Finish: Silver



EN 1154 Tested



Tested 500,000 Cycles

80 Kg



Weight Carrying Capacity



Scan QR for Installation Video



NSK-680 STD BM ₹ 3,809



NSK-680 STD ANTIQUE BRASS ₹ 4,079

Power Adjustable



EN 1154 Tested



Tested 500,000 Cycles

80 Kg



Weight Carrying Capacity

NSK-680A STD SILVER ₹ 3,315
OVERHEAD DOOR CLOSER (Scissors ARM)

Rack and Pinion Door Closer with Adjustable closing force EN 2-4
• Maximum door weight: 80kg
• Finish: Silver



NSK-6825 STD SILVER ₹ 5,860
OVERHEAD DOOR CLOSER (Scissors ARM)

Rack and Pinion Door Closer with Selectable closing force EN 3-4
• Maximum door weight: 100kg
• Finish: Silver



EN 1154 Tested



Tested 500,000 Cycles

100 Kg



Weight Carrying Capacity



NSK-780 STD SILVER ₹ 8,151
OVERHEAD DOOR CLOSER
(Scissors ARM)

Rack & Pinion Door Closer with Adjustable closing force EN 2-5
• Maximum door weight upto 100kg
• Finish: Silver



EN 1154 Tested



Tested 500,000 Cycles



WARRANTY

100 Kg



Weight Carrying Capacity

NSK-780 STD BM ₹ 9,370



NSK-836 BC DA STD SILVER ₹ 11,590
OVERHEAD DOOR CLOSER (Scissors ARM)

Rack and Pinion Door Closer with Adjustable closing force EN 3-6
• Maximum door weight: upto 120kg
• Finish: Silver



EN 1154 Tested



Tested 500,000 Cycles

5 Years

WARRANTY

120 Kg



Weight Carrying Capacity



NSK-880 STD SILVER ₹ 10,174
OVERHEAD DOOR CLOSER (Scissors ARM)

Rack & Pinion Door Closer with Adjustable closing force EN 2/3/4/5
• Maximum door weight: 100Kg
• Finish: Silver



EN 1154 Tested



Tested 500,000 Cycles

10 Years

WARRANTY

100 Kg



Weight Carrying Capacity

OVERHEAD DOOR CLOSERS

E Series



NSK-980 E STD LIGHT GREY ₹ 4,680
OVERHEAD DOOR CLOSER (SCISSORS ARM)

Rack and Pinion Door Closer with Adjustable closing force EN 2-4

- Maximum door width: 1100mm
- Maximum door weight: 80Kg
- Finish: Light Grey

80 Kg



E Series



NSK-980E TA LIGHT-GREY ₹ 5,606
OVERHEAD DOOR CLOSER (TRACK ARM)

Rack and Pinion Door Closer with Hold Open Function and Adjustable closing force EN 2-4

- Maximum door weight: 80Kg
- Finish: Light Grey

80 Kg



NSK-980 TA SSS ₹ 6,112
OVERHEAD DOOR CLOSER (TRACK ARM)

Rack and Pinion Door Closer with Hold Open Function and Adjustable Closing Force EN 2-4

- Maximum door weight: 80Kg
- Finish: Silver



80 Kg



NSK-CA-6800 .TA SSS ₹ 11,461
CAM ACTION OVERHEAD DOOR CLOSER (TRACK ARM)

Overhead Cam Action Door Closer with Hold Open Function and Adjustable Closing Force EN 2-4

- Maximum door weight: upto 80kg
- Finish: Silver



EN 1154 Tested



80 Kg



HOLD OPEN DOOR CLOSERS WITH SCISSORS ARM

Finish : Silver



EN 1154 Tested



Tested 500,000 Cycles

80 Kg



NSK-680-HO STD SILVER ₹ 4,472

Rack & Pinion Door Closer with Adjustable closing force EN 2-4

- Maximum door weight: upto 80kg
- Finish: Silver



EN 1154 Tested



Tested 500,000 Cycles

100 Kg



NSK-780-HO STD SILVER ₹ 9,309

Rack & Pinion Door Closer with Adjustable closing force EN 2-5

- Maximum door weight: upto 100kg
- Finish: Silver

OVERHEAD DOOR CLOSERS



NSK-6825-HO STD SILVER ₹ 7,017
Rack and Pinion Door Closer with Selectable closing force EN 3-4
 • Maximum door weight: upto 100kg
 • Finish: Silver

EN 1154 Tested

Tested 500,000 Cycles

100 Kg
Weight Carrying Capacity



NSK-880-HO STD SILVER ₹ 11,331
Rack & Pinion Door Closer with Adjustable closing force EN 2/3/4/5
 • Maximum door weight: upto 100kg
 • Finish: Silver

EN 1154 Tested

Tested 500,000 Cycles

100 Kg
Weight Carrying Capacity

10 Years
WARRANTY

HOLD OPEN DOOR CLOSERS WITH TRACK ARM



NSK-680-TR-HO STD BM ₹ 0000

NSK-680-TR-HO STD SILVER ₹ 5,478
Rack And Pinion Overhead Door Closer with Hold Open Function and Adjustable Closing Force EN 2-4
 • Maximum door weight: upto 80kg
 • Finish: Silver

EN 1154 Tested

Tested 500,000 Cycles

80 Kg
Weight Carrying Capacity



NSK-780-TA-HO STD BM ₹ 11,130

NSK-780-TA-HO STD SILVER ₹ 9,421
Rack And Pinion Door Closer with Hold Open Function and Adjustable Closing Force EN 2-5
 • Maximum door weight: upto 100kg
 • Finish: Silver

EN 1154 Tested

Tested 500,000 Cycles

100 Kg
Weight Carrying Capacity

5 Years
WARRANTY



NSK-880-TR-HO STD BM ₹ 0000

NSK-880-TR-HO STD SILVER ₹ 12,286
Rack And Pinion Door Closer with Hold Open Function and Adjustable Closing Force EN 2-5
 • Maximum door weight: upto 100kg
 • Finish: Silver

EN 1154 Tested

Tested 500,000 Cycles

100 Kg
Weight Carrying Capacity

10 Years
WARRANTY



NSK-680E STD SILVER ₹ 2,783
Rack and Pinion Overhead Door Closer with Adjustable Closing Force EN 2-4 by Positioning Closing Force EN 2-4
 • Minimum Door Thickness: 42mm
 • Maximum door weight: upto 100kg
 • Finish: Silver

Tested 500,000 Cycles

80 Kg
Weight Carrying Capacity

CONCEALED DOOR CLOSERS



CDC-3800 STD BM ₹ 7,460

CDC-3800 TA SILVER ₹ 6,495
CONCEALED DOOR CLOSER
Concealed Rack & Pinion Door
Closer with Hold Open Function and EN 3
 • Minimum Door Thickness: 38mm

✓
Tested 500,000
Cycles

UL fire rated

QR Code
 Scan QR for
 Installation Video

60 Kg
 Weight Carrying
 Capacity



CDC-3800E TA GREY ₹ 5,860
CONCEALED DOOR CLOSER
Concealed Rack & Pinion Door Closer with
Hold Open Function and EN 3
 • Minimum Door Thickness: 38mm
 • Maximum door weight: 60kg
 • Finish: Grey

E Series

60 Kg
 Weight Carrying
 Capacity

Power Adjustable with Back Check

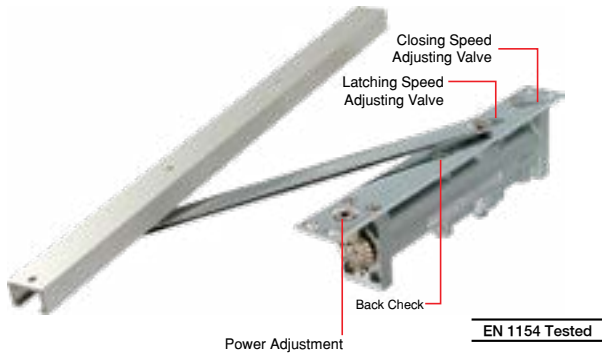

CDC-4800 TA SILVER ₹ 9,995
Concealed Rack & Pinion Door Closer
with Hold Open Function and Adjustable
Closing Force EN 2-4
 • Minimum Door Thickness: 42mm
 • Maximum door weight: upto 100kg
 • Finish: Silver

EN 1154 Tested

100 Kg
 Weight Carrying
 Capacity

QR Code
 Installation Video

Power Adjustable

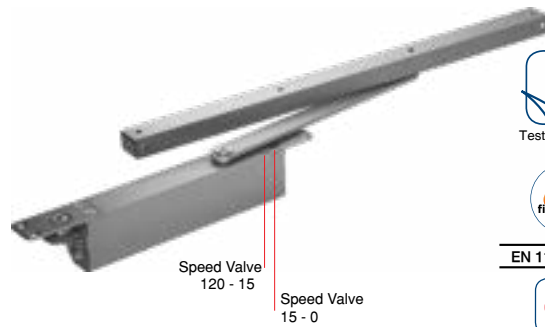

CDC-CA-6800 TA SILVER ₹ 12,607
Cam Action Concealed Door Closer
with Hold Open Function and Adjustable
Closing Force EN 2-4
 • Minimum Door Thickness: 41mm
 • Maximum door weight: 120kg
 • Finish: Silver

✓
Tested 500,000
Cycles

fire rated

EN 1154 Tested

CE

120 Kg
 Weight Carrying
 Capacity

QR Code
 Watch Video

New



CDC-3800-SL STD SILVER ₹ 6,495
Concealed Rack & Pinion Door Closer with Hold
Open Function and Adjustable
Closing Force EN 2-4
 • Minimum Door Thickness: 32mm
 • Maximum door weight: upto 60kg
 • Finish: Silver

✓
Tested 500,000
Cycles

60 Kg
 Weight Carrying
 Capacity

New



CDC-CA-6800-SL STD SILVER ₹ 12,607
Cam Action Concealed Door Closer with Hold
Open Function and Adjustable Closing
Force EN 2-4
 • Minimum Door Thickness: 40mm
 • Maximum door weight: upto 100kg
 • Finish: Silver

✓
Tested 500,000
Cycles

100 Kg
 Weight Carrying
 Capacity

OVERHEAD DOOR CLOSERS



OZ-SD-DC-60 STD SILVER ₹ 1,390
Rack & Pinion Door Closer with adjustable closing force EN 1-3
 • Mounting – Door leaf
 • Adjustable closing speed
 • Latching Speed
 • Finish: Silver



EN 1-3 Tested



Tested 100,000 Cycles



Door Width 950mm

60 Kg



Weight Carrying Capacity



NSK-CA-6800-2W TA SSS ₹ 21,942
Overhead Cam Action Door Closer with adjustable closing force EN 2-4
 • Inward and outward movement
 • Easy opening action
 • Power adjustable
 • Adjustable closing speed in two independent ranges
 • Test certificate available on request
 • Finish: Silver



EN 1154 Tested



Tested 500,000 Cycles

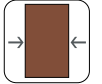

Door Width 1100mm

80 Kg



Weight Carrying Capacity



OZ-SD-DC-NEO-60 SILVER ₹ 1,610
Rack & Pinion Door Closer with adjustable closing force EN 1-3
 • Mounting – Door leaf
 • Adjustable closing speed
 • Latching Speed
 • Finish: Silver



EN 1-3 Tested



Tested 100,000 Cycles



Door Width 950mm

60 Kg



Weight Carrying Capacity



OZ-SD-DC-NEO-60 TA SILVER ₹ 1,903
Rack & Pinion Door Closer with adjustable closing force EN 1-3
 • Mounting – Door leaf
 • Adjustable closing speed
 • Latching Speed
 • Finish: Silver



EN 1-3 Tested



Tested 100,000 Cycles

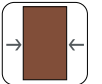

Door Width 950mm

60 Kg



Weight Carrying Capacity

ELECTROMAGNETIC DOOR CLOSERS

Available against bulk orders only



NSK-980-EMHO-TA STD SS ₹ 19,163
 Door Closer with Electromagnetic Hold Open Scissors Arm
 Finish: SSS



NSK-980-EMHO-TA-S ₹ 25,928
 Door Closer with Electromagnetic Hold Open Scissors Arm and Smoke Detector
 Finish: SSS



NSK-980-EMHO-TA STD SS ₹ 19,163
 Door Closer with Electromagnetic Hold Open Track Arm
 Finish: SSS



NSK-980-EMHO-TA-S STD ₹ 25,928
 Door Closer with Electromagnetic Hold Open Track Arm and Smoke Detector
 Finish: SSS

DOOR CLOSERS WITH MOUNTING PLATE FOR GLASS DOORS



NSK-780 STD SILVER ₹ 8,151
Rack & Pinion Door Closer with
Adjustable closing force EN 2-5



NSK-780 STD BM ₹ 9,370



NSK-780-TA-HO STD SS ₹ 9,421
Rack & Pinion Door Closer with
Hold Open Function and
Adjustable closing force EN 2-5



Tested 500,000
Cycles
EN 1154 Tested



NSK-980 E STD Light Grey ₹ 4,680
Overhead Door Closer
(Scissors Arm)



NSK-980 TA SSS ₹ 6,112
Overhead Door Closer with Hold
Open Function and Track Arm



NSK-980 E TA Light Grey ₹ 5,606
Rack and Pinion Door Closer
with Hold Open Function and
Adjustable closing force EN 2-4



**NSK-980 E TA
BM ₹ 6,572**



NSK-ACC-780 PLATE ₹ 2,332
STD SILVER
Mounting Plate for Glass Door Installation
of Door Closer NSK 780



₹ 2,680
**NSK-ACC-780
PLATE STD BM**



NSK-ACC-980-PLATE ₹ 2,210
STD SILVER
Mounting Plate for
Glass Door Installation of Door Closer
NSK 980



₹ 2,549
**NSK-ACC-980
PLATE STD BM**



**OZ-PGDH STD
SSS ₹ 4,760**
Pivot Hinge Set



OZ-PGDH STD BM ₹ 5,475



OGC-DH-2 STD SSS ₹ 4,808
Frame Rebate
Mounting Hinge (Square)



OGC-DH-2 STD BM ₹ 5,529

FLOOR SPRING

FS-8400 STD SSS ₹ 11,980

Cam Action Floor Spring with Closing Force EN3 Double Cylinder (Heavy Duty)

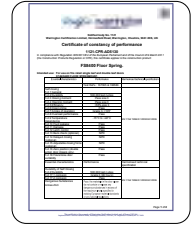

EN 1154 Tested

- Maximum door weight **80kg**
- Tested to: 5,00,000 cycles



FS-8400 STD BM
₹ 14,179



FS-8400 STD GOLD M-PVD
₹ 14,791



FS-8400 STD ROSE GOLD M-PVD
₹ 14,791



FS-8400 STD ANTIQUE BRASS
₹ 14,791



FS-8400 STD WD
₹ 12,998

FS-8300 STD SSS ₹ 11,030

Double Cylinder Floor Spring with Cam Action Force EN3 for better performance on internal low traffic doors



- Maximum door weight **80kg**
- Tested to: 5,00,000 cycles



FS-8400 w/o HO STD STD* ₹ 11,935

Cam Action Floor Spring with Closing Force EN3 Double Cylinder (Heavy Duty)



- Maximum door weight **80kg**
- Tested to: 5,00,000 cycles

*Against on request

EN 1154 Tested



FLOOR SPRING

FS-8400-S STD SSS ₹ 13,623

Cam Action with Closing Force EN3
Double Cylinder with Stronger Spring Inside



- Super Spring (stronger spring inside)
- Maximum door weight 80kg
- Tested to : 10,00,000 cycles



**FS-8400-S STD
BM
₹ 15,672**



**FS-8400-S STD
GOLD M-PVD
₹ 16,347**



**FS-8400-S STD
ANTIQU BRASS
₹ 16,347**

Super Spring

**10
Years***
GUARANTEE

80 Kg
Weight Carrying
Capacity



EN 1154 Tested



Installation Video

FS-9000 STD SSS ₹ 12,713

Cam Action Floor Spring with Closing Force EN4
Double Cylinder (Heavy Duty)



**3
Years***
WARRANTY

120 Kg
Weight Carrying
Capacity



EN 1154 Tested

- Maximum door weight 120kg
- Tested to: 5,00,000 cycles



**FS-9400 STD SSS
BM
₹ 16,273**

FS-9400 STD SSS ₹ 14,138

Cam Action Floor Spring with Closing Force EN4
Double Cylinder (Heavy Duty)



- Maximum door weight 150kg
- Tested to: 5,00,000 cycles

EN 1154 Tested



150 Kg
Weight Carrying
Capacity

**3
Years***
WARRANTY

FLOOR SPRING

FS-10400 STD STD ₹ 16,216

Cam Action Floor Spring with Closing Force EN4
Double Cylinder (Heavy Duty)



- Maximum door weight **270kg**
- Tested to: 5,00,000 cycles

EN 1154 Tested

270 Kg
Weight Carrying Capacity

3 Years*
WARRANTY

FS-11400 STD STD ₹ 17,515

Power Adjustable Floor Spring for Heavy Wooden / Glass Doors
Ideal for Banquet Halls, EN 2-6

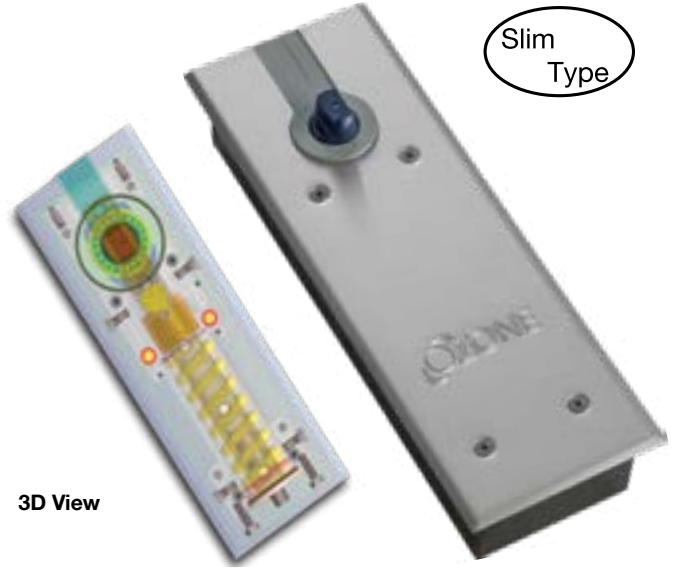

- Door weight range **65kg-200kg**
- Power adjustable

65-200 Kg
Weight Carrying Capacity

3 Years*
WARRANTY

OFH-5500E-TPBPE1 STD STD ₹ 4,545

Single Cylinder Floor Spring for
Wood/Aluminium/Framed Doors, EN2



Product Set includes Top & Bottom Pivot for Wooden & Aluminium Door



Maximum door weight **45kg**



High and Low
Adjustment Screw

45 Kg
Weight Carrying Capacity

OFS-5800SD STD STD ₹ 7,007

Single Cylinder Floor Spring for Small Glass Doors, EN3

Product Set includes



*Patch fittings will not be sold individually.



- Set includes: Floor Spring, Top Patch & Bottom Patch
- Maximum door weight **55kg**

55 Kg
Weight Carrying Capacity

FLOOR SPRING

OFS-6400SD+ STD SSS ₹ 7,007
Single Cylinder Floor Spring for Glass Doors, EN3



Product Set includes

*Patch fittings will not be sold individually



OPF-2 SD
Top Patch



OPF-3 SD
Bottom Patch

Set includes: Floor Spring, Top Patch & Bottom Patch
Maximum door weight **70kg**

70 Kg



Weight Carrying Capacity

OFS-6400-TPBPE1 STD STD ₹ 6,359
Single Cylinder Floor Spring for Wood/Aluminium/Framed Doors, EN2



Product Set includes Top & Bottom Pivot for Wooden & Aluminium Door



70 Kg



Weight Carrying Capacity



High and Low Adjustment Screw

OFH-6600-E STD SSS ₹ 4,923
Single Cylinder Floor Spring for Wood/Aluminium/Glass Doors, EN4

E Series



with up & down Adjustment ↑ ↓

Maximum door weight **85kg**

85 Kg



Weight Carrying Capacity

OFH-6600-E STD BM ₹ 5,661



FLOOR SPRING ACCESSORIES

Finish : SSS & Black Matt

E Series

OFS-ACC-TPBPE1 STD SSS ₹ 1,700
Top & Bottom Pivot for
Wooden/Aluminium Door



OFS-ACC-OP-L/R SS ₹ 2,027
Offset Pivot Set for
Wooden/Aluminium Doors



OFS-ACC-TP/BP STD SSS ₹ 1700
Top & Bottom Pivot
for Wooden/Aluminium Door



OFS-ACC-MH1 STD SS ₹ 1,534
Mini Floor Hinge Compatible
with Patch Fittings



OFS-ACC-PH-TP/BP* ₹ 6,811
Top & Bottom Pivot for Wooden/
Aluminium Door



*Available on request

OFS-ACC-GDP SS ₹ 491
Top Pivot for Patch/Point
Fitting Doors



TRANSOM CLOSERS

OTC-7400 STD STD ₹ 16,552
Transom Mounted Door Closer



Specifications
**Cam action transom door closer
with closing force EN 2**

- Maximum opening angle 130 both sides
- Maximum door weight 70Kg
- Maximum door width 850mm
- Suitable for framed door



OTC-8400 STD STD ₹ 16,552
Transom Mounted Door Closer



Specifications
**Cam action transom door closer
with closing force EN 3**

- Maximum opening angle 130 both sides
- Maximum door weight 105Kg
- Maximum door width 950mm
- Suitable for framed door



ACCESSORIES for Transom Mounted Closers (Part of Standard Package)



Bottom Pivot with Bearing



Mounting Bracket for Transom Closer at Spindle Side



Mounting Bracket for Transom Closer at the end



Arm to accept Transom Closer Spindle to be mounted into the channel on door top & secure with blanking tape

**THE ORIGINAL SELF CLOSING PATCH FITTING
FOR WOODEN DOORS**



Finish : SSS



Specifications:

- Quick and easy installation
- Suitable door weight: Maximum 100kg
- Hold Open at 90
- Material: SS 304

Standard packing includes
top pivot set



EN 1154 Tested

**THE ORIGINAL SELF CLOSING PATCH FITTING
OCFH-W-100 STD SSS ₹ 19,736**

Suitable door width: 950mm
Suitable door thickness: >40mm
Suitable for Internal Doors with Power Size 3
Standard package comes along with Top Pivot set



**THE ORIGINAL SELF CLOSING PATCH FITTING
OCFH-W-105 STD SSS ₹ 23,264**

Suitable door width: 1250mm
Suitable door thickness: >50mm
Suitable for External Doors with Power Size 5

CONTRACTOR KY SERIES - OCX.KY

Finish : CP/SN



OCX.KY1.STD CP/SN ₹ 1,789
Material : Zinc Alloy
Finish : CP/SN



OCX.KY2.STD CP/SN ₹ 1,789
Material : Zinc Alloy
Finish : CP/SN



OCX.KY3.STD CP/SN ₹ 2,442
Material : Zinc Alloy
Finish : CP/SN



OCX.KY4.STD CP/SN ₹ 2,563
Material : Zinc Alloy
Finish : CP/SN



OCX.KY5.STD SN ₹ 1,707
Material : Zinc Alloy
Finish : CP/SN

CONTRACTOR BT SERIES - OCX.BT
(Suitable for Bathroom Doors)

Finish : CP/SN



OCX.BT1 STD CP/SN* ₹ 1,802
Handle set with Baby Latch
Finish : CP/SN



OCX.BT2 STD CP/SN* ₹ 1,789
Handle Set with Baby Latch
Material : Zinc Alloy
Finish : CP/SN



OCX.BT3 STD CP/SN* ₹ 2,470
Handle set with Baby Latch
Finish : CP/SN



OCX.BT4 STD CP/SN* ₹ 2,590
Handle set with Baby Latch
Finish : CP/SN

New



OCX.BT5 STD SN ₹ 1,707
Handle set with Baby Latch
Finish : SN

*Available on request

CONTRACTOR PRO SERIES - OCXP

Finish : CP/SN



OCXP.001.K60 RS CP/SN ₹ 5,005
OCXP.001.N60 RS CP/SN ₹ 5,059
OCXP.001.K70 RS CP/SN ₹ 5,325
OCXP.001.N70 RS CP/SN ₹ 5,325
 Kit Includes: Handle set, Mortise Lock Body, & Euro Profile Cylinder
 Material : Zinc Alloy
 Finish : CP/SN



OCXP.001.K60 8" CP/SN ₹ 4,538
OCXP.001.N60 8" CP/SN ₹ 4,525
OCXP.001.K70 8" CP/SN ₹ 4,806
OCXP.001.N70 8" CP/SN ₹ 4,806
 Kit Includes: Handle set, Mortise Lock Body, & Euro Profile Cylinder
 Material : Zinc Alloy
 Finish : CP/SN



OCXP.002.K60 RS CP/SN ₹ 4,525
OCXP.002.N60 RS CP/SN ₹ 4,525
OCXP.002.K70 RS CP/SN ₹ 4,699
OCXP.002.N70 RS CP/SN ₹ 4,792
 Kit Includes: Handle set, Mortise Lock Body, & Euro Profile Cylinder
 Material : Zinc Alloy
 Finish : CP/SN



OCXP.002.K60 8" CP/SN ₹ 4,538
OCXP.002.N60 8" CP/SN ₹ 4,525
OCXP.002.K70 8" CP/SN ₹ 4,765
OCXP.002.N70 8" CP/SN ₹ 4,806
 Kit Includes: Handle set, Mortise Lock Body, & Euro Profile Cylinder
 Material : Zinc Alloy
 Finish : CP/SN



OCXP.002.K60 10" CP/SN ₹ 4,538
OCXP.002.N60 10" CP/SN ₹ 4,538
OCXP.002.K70 10" CP/SN ₹ 4,699
OCXP.002.N70 10" CP/SN ₹ 4,792
 Kit Includes: Handle set, Mortise Lock Body, & Euro Profile Cylinder
 Material : Zinc Alloy
 Finish : CP/SN



OCXP.002.K60 ME CP/SN* ₹ 8,876
 Kit Includes: Pull handle, Rose handle, Lock body, & Cylinder

PREMIUM SERIES - OPX

Finish : CP/SN



OPX.002.PL 10" CP/SN*
 Pull Handle 10" ₹ 3,310



OCXP.002.PL 10" CP/SN*
 Pull Handle 10" ₹ 3,364



OPX.001 RS CP/SN ₹ 4,124
 Handle with Square Rose
 Material : Zinc Alloy
 Finish : CP/SN



OPX.002 RS CP/SN ₹ 3,604
 Handle with Square Rose
 Material : Zinc Alloy
 Finish : CP/SN

*Available on request

CONTRACTOR SERIES - OCX

Finish : CP/SN



- OCX.001.K60 8" CP/SN ₹ 3,738**
- OCX.001.N60 8" CP/SN ₹ 3,738**
- OCX.001.K70 8" CP/SN ₹ 3,991**
- OCX.001.N70 8" CP/SN ₹ 4,031**

Kit Includes: Handle set, Mortise Lock Body, & Euro Profile Cylinder
Material : Stainless Steel & Zinc Alloy
Finish : CP/SN



- OCX.001.K60 10" CP/SN ₹ 3,991**
- OCX.001.N60 10" CP/SN ₹ 3,991**
- OCX.001.K70 10" CP/SN ₹ 4,272**
- OCX.001.N70 10" CP/SN ₹ 4,351**

Kit Includes: Handle set, Mortise Lock Body, & Euro Profile Cylinder
Material : Stainless Steel & Zinc Alloy
Finish : CP/SN



- OCX.004.K60 RS SN ₹ 3,991**
- OCX.004.N60 RS SN ₹ 4,018**
- OCX.004.K70 RS SN ₹ 4,272**
- OCX.004.N70 RS SN ₹ 4,365**

Kit Includes: Handle set, Mortise Lock Body, & Euro Profile Cylinder
Material : Zinc Alloy
Finish : SN



- OCX.006.K60 8" CP/SN ₹ 3,164**
- OCX.006.N60 8" CP/SN ₹ 3,271**
- OCX.006.K70 8" CP/SN ₹ 3,430**
- OCX.006.N70 8" CP/SN ₹ 3,551**

Kit Includes: Handle set, Mortise Lock Body, & Euro Profile Cylinder
Material : Zinc Alloy
Finish : CP/SN



- OCX.006.K60 RS CP/SN ₹ 3,671**
 - OCX.006.N60 RS CP/SN ₹ 3,738**
- Kit Includes: Handle set, Mortise Lock Body, & Euro Profile Cylinder
Material : Zinc Alloy
Finish : CP/SN



- OCX.008.K60 8" SN ₹ 2,459**
- OCX.008.N60 8" SN ₹ 2,572**
- OCX.008.K60 10" SN ₹ 2,986**
- OCX.008.N60 10" SN ₹ 3,124**

Kit Includes: Handle set, Mortise Lock Body, & Euro Profile Cylinder
Material : Zinc Alloy
Finish : SN



- *OCX.004.K70 8" SN ₹ 4,351**
 - *OCX.004.N60 8" SN ₹ 4,191**
- Kit Includes :Handle set, Lock Body, & Cylinder



- *OCX.004.K70 10" SN ₹ 5,192**
 - *OCX.004.N60 10" SN ₹ 4,940**
- Kit Includes :10" Handle, Lock Body, & Cylinder

*Available on request

INOX SERIES - Solid Casted

Finish : SSS



OMH-11C STD SSS ₹ 3,231
Mortise Handle in SSS Finish
Material : Stainless Steel
Grade : 304
Finish : SSS



OMH-22C STD SSS ₹ 3,190
Mortise Handle in SSS Finish
Material : Stainless Steel
Grade : 304
Finish : SSS



***OMH-33C STD SSS ₹ 3,470**
Mortise Handle in SSS Finish
Material : Stainless Steel
Grade : 304
Finish : SSS



***OMH-44C STD SSS ₹ 4,272**
Lever Handle in SSS Finish



TUBULAR MORTISE HANDLES - OMH

Finish : SSS/PSS & Black Matt



OMH-11N STD SSS/PSS ₹ 1,909
L-shape Mortise Handle in SSS Finish
Material : Stainless Steel
Grade : 304
Finish : PSS/SSS



₹ 1,998
OMH-33N STD BM

OMH-33N STD SSS ₹ 1,841
Mortise Handle for Narrow Style Doors
Material : Stainless Steel
Grade : 304
Finish : SSS



₹ 1,723
OMH-11LN STD BM

OMH-11LN STD SSS ₹ 1,589
Mortise Handle for Narrow Style Doors
Material : Stainless Steel
Grade : 304
Finish : SSS



OMH-11 STD SSS ₹ 1,723
Tubular Mortise Handle in SSS Finish
Material : Stainless Steel
Grade : 304
Finish : SSS



OMH-11 19mm STD SSS ₹ 1,553
Tubular Mortise Handle in SSS Finish
Material : Stainless Steel
Grade : 304
Finish : SSS



OMH-11L STD SSS ₹ 1,589
Mortise Handle in SSS Finish
Material : Stainless Steel
Grade : 304
Finish : SSS



OMH-33 STD SSS ₹ 1,841
D-Type Mortise Handle
Material : Stainless Steel
Grade : 304
Finish : SSS



OMH-33P STD SSS ₹ 3,326
D-Type Mortise Handle with Plate
Material : Stainless Steel
Grade : 304
Finish : SSS



OMH-44 STD SSS ₹ 1,668
Mortise Handle in SSS Finish
Material : Stainless Steel
Grade : 304
Finish : SSS



OMH-55 STD SSS ₹ 1,655
Mortise Handle in SSS Finish
Material : Stainless Steel
Grade : 304
Finish : SSS



OPKL-K2N-STD SSS ₹ 2,122
Mortise Handle with POD Lock in SSS Finish
Material : Stainless Steel
Finish : SSS

New



OPKL-K2N-C STD SS ₹ 2,078
Mortise Handle with POD Lock in SSS Finish
Material : Stainless Steel
Finish : SSS

New



OPKL-B2N-C STD SS ₹ 1,896
Mortise Handle with POD Lock in SSS Finish
Material : Stainless Steel
Finish : SSS

Finish : SSS, CP & Black Matt

MORTISE LOCK BODY

SASH LOCK FOR REBATED DOORS



OML-11A-F 45/85 SSS ₹ 2,256

OML-11A-F 55/72 SSS ₹ 2,322

Mortise Lock Body Fire Rated with Dead Bolt & Latch Bolt



OML-11A 45x85 MM SSS ₹ 1,789

Closed Body Mortise Lock with Strike Plate, Double Throw (SS-304) Dead Bolt & Latch Bolt (SS-304)



OML-22A-4P-55x85 Std ₹ 2,122

Mortise Lock Body with Double Throw Four Dead Bolts & Latch Bolt



OML-11-E 50x50MM CP ₹ 761

Closed Body Mortise Lock with Dead Bolt & Latch Bolt Suitable to use with 8" Plate Handles



OML-11-E2 45x85 SSS ₹ 895

Closed Body Mortise Lock with Dead Bolt & Latch Bolt Finish: SN/BM/AB



OML-11 60x85mm SSS ₹ 1,603

Closed Body Mortise Lock with Dead Bolt & Latch Bolt



OML-DD-R 50x85MM SSS ₹ 2,563

OML-DD-L 50x85MM SSS ₹ 2,563

Mortise Lock Body with Latch Bolt & Dead Bolt for **Wooden Double Doors**

NARROW MORTISE SASH LOCK



OML-33 55/72 MM SSS ₹ 1,883

Fire Rated Mortise Lock Body with Deadbolt & Latch bolt



OML-33A 30x85MM SSS ₹ 1,348

Narrow Style Mortise Lock Body for Aluminium Doors with Latch & Dead Bolt Finish: SS



OML-33A 35x85MM SSS ₹ 1,348

Narrow Style Lock Body for Aluminium Doors with Latch & Dead Bolt Finish: SS & BM



OZML-DL1-25MM SSS ₹ 1,155

Narrow Style Mortise Lock Body with Dead Bolt (Also Suitable for Aluminium Framed Doors)

MORTISE LOCK BODY

DEAD LOCK



OZML-DL1 55MM SSS ₹ 1,482
Closed Body Mortise Lock with Strike Plate, Double Throw Dead Bolt



OZML-DL1-F 55MM SSS ₹ 1,655
Close Body Mortise Lock with Strike Plate, Double Throw Dead Bolt



OZML-DL1-E 50MM SSS ₹ 828
Closed Body Mortise Lock with Strike Plate, Double Throw Dead Bolt

ROLLER LATCH



₹ 1,869
OML-44-RL 60x85mm SSS
Roller Lock Body

SHAFT LOCK



₹ 895
OML-SL-STD SSS
Mortise Lock Body with Dead Bolt, operated with Allen Key

LATCH LOCK



₹ 661
OZML-L1-E-O 46.5MM SSS
Mortise Lock Body with Soft Closing Latch Bolt

EURO PROFILE CYLINDERS FOR MORTISE LOCKS

Finish : SN & Black Matt

DEFEND PRO SERIES

Single Security Computerized Key System

Master & Grand Master Key Available

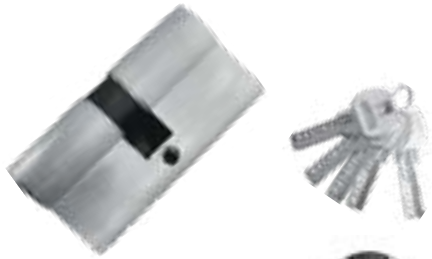

OMC-11-K2K-P-60MM SN ₹ 1,187
OMC-11-K2K-P-70MM SN ₹ 1,455
OMC-11-K2K-P-80MM SN ₹ 1,521
Both Side Keys
Finish: SN/ BM



OMC-11-K2N-P-60MM SN ₹ 1,280
OMC-11-K2N-P-70MM SN ₹ 1,482
OMC-11-K2N-P-80MM SN ₹ 1,521
One Side Key One Side Knob
Finish: SN/ BM



OML-CPP STD SSS ₹ 388
Cylinder Pull Plate
Finish: SSS

DEFEND SERIES - Normal Key

Master & Grand Master Key Available



OMC-22-HC-KNOB-N2-45MM SN ₹ 782
Half Cylinder with Knob
Finish: SN



OMC-22-HC-KEY-N-45MM SN ₹ 661
Half Cylinder with
3 Brass Normal Keys
Finish: SN

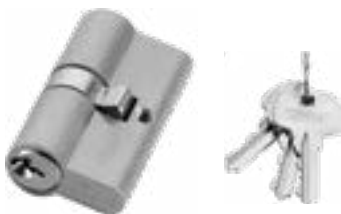

OMC-22-K2K-N 60MM SN ₹ 1,028
OMC-22-K2K-N 70MM SN ₹ 1,094
OMC-22-K2K-N 80MM SN ₹ 1,148
Both Side Keys
Finish: BM



OMC-22-BT-N 60MM SN ₹ 955
OMC-22-BT-N 70MM SN ₹ 1,028
OMC-22-BT-N 80MM SN ₹ 1,135
Bathroom Type
Finish: SN/BM



OMC-22-K2N-N 60MM SN ₹ 1,241
OMC-22-K2N-N 70MM SN ₹ 1,289
OMC-22-K2N-N 80MM SN ₹ 1,362
OMC-22-K2N-N 90MM SN ₹ 0000
One Side Key One Side Knob
Finish: SN/BM

E Series

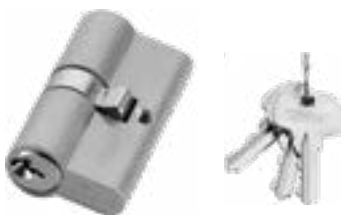

OMC-22E-K2K 60MM SN ₹ 809
OMC-22E-K2K 70MM SN ₹ 921
Finish: SN/BM/AB

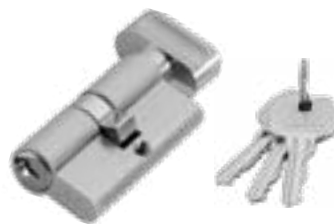

OMC-22E-K2N 60MM SN ₹ 921
OMC-22E-K2N 70MM SN ₹ 1,034
Finish: SN/BM/AB



OMC-22E-BT-N 60MM SN ₹ 742
Finish: SN/BM/AB

NIGHT LATCH LOCKS

Features:

- High strength latch bolt/ dead bolt
- Safety knob ensures the security and privacy
- Restrict unauthorised access from outside



OZ-NL-11R STD AB ₹ 1,725

OZ-NL-11L STD AB ₹ 1,725

Mini Latch

- Night latch for inside opening doors
- Right & left handed
- High security 3 brass keys



OZ-NL-33 STD AB ₹ 4,190

Night Latch (Single Latch+ Double Bolt)

- Reversible latch bolt
- Double dead bolt with double stroke
- Reversible computerized keys - 4nos. (Brass)
- Suitable for inside/outside opening doors

GRILL AND DOOR LOCKS



OZ-NL-55 STD AB ₹ 1,529

Interlock with 3 Stroke

- Dead bolt option available after shifting latch upwards
- Single sliding bolt with 3 stroke
- Reversible computerized keys - 4nos. (Brass)
- Door thickness:- 40mm

Suitable for:

- Wooden or metal doors
- Single or double doors
- Door Thickness: 30-70mm
- Locking from outside by key, inside by knob



OZ-NL-22 STD AB ₹ 2,480

Night Latch

- Reversible latch bolt
- Double stroke dead bolt
- Reversible computerized Key - 4nos. (Brass)
- Suitable for inside/outside opening doors
- Holdback feature prevents any lockout situations



OZ-NL-44 STD AB ₹ 3,518

Tri Bolt Night Latch

- Three strong bolt for triple bolt security
- No fear of accidental locking
- Dead bolts with double stroke
- Reversible computerized keys - 4nos. (Brass)
- Suitable for inside/outside opening doors



OZ-NL-66 STD AB ₹ 1,808

Interlock with 6 Stroke

SERIES
SPEEDY

Finish : AB/SSS



Watch Video



Watch Video



Watch Video

NIGHT LATCH LOCKS

SERIES
SPEEDY

5
Years
WARRANTY

Features:

- High strength latch bolt/ dead bolt
- Safety knob ensures the security and privacy
- Restrict unauthorised access from outside

Suitable for:

- Wooden or metal doors
- Single or double doors
- Door Thickness: 30-70mm
- Locking from outside by key, inside by knob



OZ-NL-11R STD SSS ₹ 1,642
OZ-NL-11L STD SSS ₹ 1,642
Mini Latch

- Night latch for inside opening doors
- Right & left handed
- High security 3 brass keys



OZ-NL-22 STD SSS ₹ 2,363
Night Latch



Watch Video

- Reversible latch bolt
- Double stroke dead bolt
- Reversible computerized Key - 4nos. (Brass)
- Suitable for inside/outside opening doors
- Holdback feature prevents any lockout situations



OZ-NL-33 STD SSS ₹ 3,991
Night Latch (Single Latch+ Double Bolt)

- Reversible latch bolt
- Double dead bolt with double stroke
- Reversible computerized keys - 4nos.(Brass)
- Suitable for inside/outside opening doors



OZ-NL-44 STD SSS ₹ 3,351
Tri Bolt Night Latch



Watch Video

- Three strong bolt for triple bolt security
- No fear of accidental locking
- Dead bolts with double stroke
- Reversible computerized keys - 4nos. (brass)
- Suitable for inside/outside opening doors

GRILL AND DOOR LOCKS



OZ-NL-55 STD SSS ₹ 1,455
Interlock with 3 Stroke

- Dead bolt option available after shifting latch upwards
- Single sliding bolt with 3 stroke
- Reversible computerized keys - 4nos. (Brass)
- Door thickness:- 40mm



OZ-NL-66 STD SSS ₹ 1,723
Interlock with 6 Stroke



Watch Video

CYLINDRICAL KNOB LOCKS

(Available in 60MM & 70MM Backset)

Finish : SSS



OCKL-11N 60mm STD SSS ₹ 1,162
OCKL-11N 70mm SSS ₹ 1,174
Knob Lock with Key
Operation & Push Button



OCKL-22N 60mm STD SSS ₹ 1,075
OCKL-22N 70mm SSS ₹ 1,075
Knob Lock with Push
Button & Coin Release



OCKL-33N 60mm STD SSS ₹ 1,075
OCKL-33N 70mm SSS ₹ 1,289
Knob Lock with both
side Active Knobs

PANIC DOOR HARDWARE

Finish : SSS



1 Point Modular
Push Panic Bar for Single Door

OZ-PB-TCR-F-842MM SSS ₹ 14,150
Maximum Door Width : Upto 1100

OZ-PB-TCR-F-1020MM SSS ₹ 18,421
Maximum Door Width : Upto 1400

Features :

- Push bar for fire and smoke check doors
- Stainless steel latch and security anti-thrust latch
- Certified as per UL 10C 1-3 HOURS FIRE RATED
 - For Hollow Metal Door: 3 Hours Fire Rated
 - For Wooden Door: 1.5 Hours Fire Rated



2 Point Modular
Push Panic Bar for Double Door

OZ-PB-TCV-F-842MM SSS ₹ 18,354
Maximum Door Width : 1100/2400

OZ-PB-TCV-F-1020MM SSS ₹ 20,557
Maximum Door Width : 1400/2400

Accessories



OZ-PB-TCTRIM-F-STD SSS ₹ 4,306
External Trim



OZ-PBV-DLS-Std ₹ 1,222
Overlapping Cover
Strike Plate

FIRE RATED CROSS PUSH PANIC BAR

Finish : SSS



OZ-PB-CRV-F-900mm Silver ₹ 10,719
Maximum Door Width: Upto 1200
Door Height 2300mm

Features :

- Cross bar for fire and smoke check doors
- 3 hour fire certified
- Suitable for door Thickness 40-60mm
- Connecting rod length: 900mm
- Compatible with external trim
OZ-PB- CRTRIM-F-STD Silver



OZ-PB-CRR-F-900mm Silver ₹ 7,876
Maximum Door Width : Upto 1200
Door Height 2300mm

Features :

- Cross bar for fire and smoke check doors
- 3 hours fire certified
- Suitable for door Thickness 40-60mm
- Connecting rod length: 900mm
- Compatible with external trim
OZ-PB- CRTRIM-F-STD Silver

Accessory



OZ-PB-CRTRIM-F-N STD Silver ₹ 3,725
External Trim Handle

Features :

- Rectangular External Trim with lever handle for fire and smoke check doors
- 3 hour fire certified
- EN-1634-1:2008
- Maximum Door Thickness: 75mm
- Aluminum material grade
- Powder Coated finish
- Solid Square Spindle
- Master Key available on request Replaceable EP Cylinder with one side key operation
- Ideal for emergency exit of metal/Wooden single/double door

GRAVITY DOOR COORDINATOR



OZ-GDC STD SILVER ₹ 7,910
For sequencing door closing action



OZ-GDC-F-STD SILVER ₹ 8,545
For sequencing door closing action



Watch Video

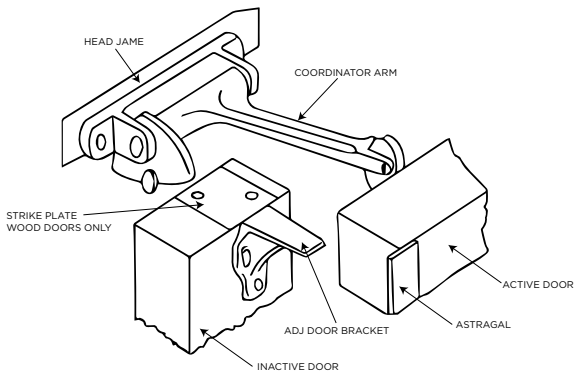

Features

- Sequences the Door Closing i.e. roller arm stops active door from closing before the inactive door
- Gravity action arm and door bracket are adjustable on the jamb for ease of installation
- Nylon roller to enable the inactive door to easily operate

Specifications:

- Device: Non-handed & reversible
- Projection: 6-1/2"
- Material: Forged brass with nylon roller
- Finish: Satin chrome



OZ-PB-CRTRIM-H STD SILVER ₹ 4,850
External trim handle for panic bar

Features

- Rectangular external trim with lever handle for fire and smoke check doors
- Aluminum material grade
- Powder coated finish
- Solid square spindle
- Master key available on request replaceable EP cylinder with one side key operation

Applications

- Ideal for metal and wooden single/double leaf emergency exit doors



3 hours
Fire Certified



Door Thickness
75mm

DOOR GUARD & STOPPER



OZ-DG-B-11-E STD SN
Door Guard Buckle
Type ₹ 921

E Series



OZ-DG-B-11 STD SN
Door Guard Buckle
Type ₹ 1,289



OZ-DG-22 STD SN
Door Chain ₹ 1,174



OZ-DST-11 STD SN
Door Stopper ₹ 254



OZ-DST-22 STD SN
Door Stopper ₹ 575



OZ-WST-11 STD SSS
Wall Mounted ₹ 315
Door Stopper



OZ-DST-33F-N
STD SS ₹ 788
Door Stopper



OZ-DST-44M STD SS
Magnetic Door ₹ 1,696
Stopper for Wooden
Doors



OZ-DST-55E STD SN
Door Stopper for ₹ 334
Wooden & Framed
Doors

E Series



OZ-MC Std Std
Magnetic Door ₹ 119
Catcher for Cabinets

₹ 2,985
*OWDS-11 900MM AN
OWDS-11 1Mtr AN
Drop Down Seal
₹ 3,300



*against on request



₹ 795
OZ-DE-1 25MM SS
OZ-DE-1 25MM BM
180° Door Viewer
₹ 825



₹ 529
OZ-DE-1-E 16MM SS
OZ-DE-1-E 16MM BM
180° Door Viewer
₹ 575

E Series



₹ 1,014
OZ-CFB-DP 300MM SSS
Concealed Flush Bolt

ESCUTCHEON WITH KNOBS

Finish : SSS



OML-LR STD SSS ₹ 467
Round Escutcheon



OML-N-LR STD SSS ₹ 467
Narrow Escutcheon



OIL-R STD SSS ₹ 1,001
Escutcheon with knob &
occupied indicator for OML-11BT



OIL-S STD SSS ₹ 1,094
Escutcheon with knob & occupied
indicator for OML-11BT

*Available on request

FOOT PLATE FOR TOUCH-LESS DOOR ACCESS

Finish : SSS



OZ-FP-01 ₹ 743
Foot Plate



Specifications:

- Suitable to use on wooden, steel, and aluminium framed doors
- Prevents spread of germs
- Maximum door load capacity: 80kg
- Finish: SSS
- SS 304 Grade Material
- Dimensions (mm): 70(L) x 100(W) x 3(Th)

ALDROP

Finish : PSS/SSS

Available against bulk orders only



OZ-ALD-03 16*300mm
Finish: SSS ₹ 2,632



OZ-ALD-01 16*200mm ₹ 1,895
OZ-ALD-02 16*250mm ₹ 2,103
Finish: SSS

TOWER BOLTS

Finish : PSS/SSS

STANDARD TYPE



Standard Sizes

		E Series			
		Grade: SS 304	Grade: SS 202		
₹ 841	OZ-TB-S 12" SSS	OZ-TB-SE 12" SSS	₹ 488		
₹ 701	OZ-TB-S 10" SSS	OZ-TB-SE 10" SSS	₹ 422		
₹ 567	OZ-TB-S 8" SSS	OZ-TB-SE 8" SSS	₹ 340		
₹ 413	OZ-TB-S 6" SSS	OZ-TB-SE 6" SSS	₹ 247		
₹ 269	OZ-TB-S 4" SSS	OZ-TB-SE 4" SSS	₹ 167		
Finish: SSS		Finish: SSS			

Also available in **PSS/SSS** finish with **SS 304** Grade

₹ 1,255

₹ 1,655

OZ-TB-S 18" SSS & OZ-TB-S 24" SSS available on request
OZ-TB-SE 18" SSS & OZ-TB-SE 24" SSS available on request
₹ 881 ₹ 1,162

SQUARE TYPE



Standard Sizes

		SS 304-SSS	
₹ 921	OZ-TB-S11 12" SSS		
₹ 742	OZ-TB-S11 10" SSS		
₹ 607	OZ-TB-S11 8" SSS		
₹ 474	OZ-TB-S11 6" SSS		
₹ 315	OZ-TB-S11 4" SSS		

₹ 1,322

₹ 1,802

OZ-TB-S11 18" SSS & OZ-TB-S11 24" SSS available on request

CENTRAL PIVOT HINGE FOR WOODEN DOOR

 New

Features

- 360° rotation
- Free rotate inside or outside
- Equal opening on both side of axis
- Hold open at 90°
- Concealed Hardware

Specifications

- Weight carrying capacity upto 200kg
- Door width 2500mm
- Suitable door thickness 50mm
- Angle of opening 360°
- Closing speed adjustment
- Latching speed adjustment
- Hold-Open feature

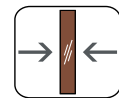
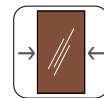
Door Thickness
≥ 50mmDoor Width
2500mm200kg
Weight Carrying
Capacity

OCFH-RD-W 200kg SSS ₹ 27,454

ADJUSTABLE 3D INVISIO HINGE

Available Finishes
 Silver Black Matt Champagne Gold G-PVD



Door Hardware

Product Image							
Product Code	Oz-InvH-40 Std	Oz-InvH-60 Std	Oz-InvH-80 Std	Oz-InvH-100F Std*	Oz-InvH-120 Std*	Oz-InvH-150F Std	Oz-InvH-200F Std
MRP	₹ 2,512	₹ 2,650	₹ 4,929	₹ 7,526	₹ 7,367	₹ 9,911	₹ 15,370
Fire Rated	No	No	No	Yes	No	Yes	Yes
Weight Per Pair (KG)	40kg	60kg	80kg	100kg	120kg	150kg	200kg
Minimum Door Thickness	40mm	35mm	30mm	40mm	40mm	40mm	40mm
Max Door Width	900mm	900mm	900mm	900mm	940mm	900mm	900mm

STAINLESS STEEL FLAP HINGES



OZ-2BB-FP 5x3x3 SSS ₹ 555
OZ-2BB-FP 5x3x3 BM ₹ 681
OZ-2BB-FP 4x3x3 SSS ₹ 434
OZ-2BB-FP 4x3x3 BM ₹ 470



OZ-2BB-FP-SL 5x3x3 SSS ₹ 588
OZ-2BB-FP-SL 5x3x3 BM ₹ 638



SS BUTT HINGES

*With Fixing Screws For Wooden Doors

Finish : SSS

SS Butt Hinges with Four Ball Bearings*

SS-304



OZ-SSBH 4x3x2.5MM SSS
₹ 481

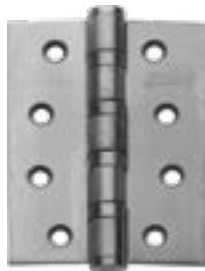

OZ-SSBH 4x3x3MM SSS
₹ 542



OZ-SSBH 5x3x3MM SSS
₹ 626



OZ-SS BH 4x3x2.5MM SSS
₹ 481

SS Butt Hinges with Two Ball Bearings*

SS-304

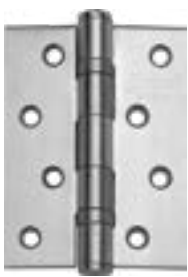

OZ-BH-2BB
4x3x2.5MM SSS
₹ 448

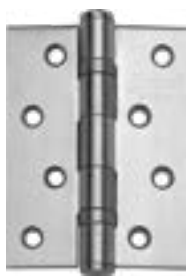

OZ-BHF-2BB-Z
4x3x3MM SSS
₹ 467

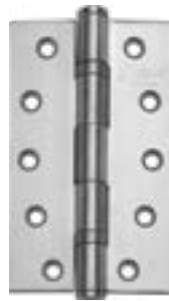

OZ-BH-2BB
5x3x3MM SSS
Finish:BM
₹ 595



OZ-BH-2BB
4X3X3MM SSS
₹ 461



OZ-BH-2BB-E
4x3x3MM SSS
₹ 360

Fire Rated Butt Hinges with Two Ball Bearings*

SS-304



OZ-BHF-2BB-C 4x3x3MM SSS ₹ 467

SS Butt Hinges with & without Ball Bearings

SS-304



OZ-BH-NBB
4x2.5x2.5MM SSS ₹ 269



OZ-BH-NBB
5x2.5x2.5MM SSS ₹ 318

Economy Series without Ball Bearings

E Series
SS-202

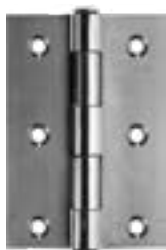

OZ-BH-NBB-E
3x2x1.3MM SSS ₹ 82



OZ-BH-NBB-E
4x2.5x2.5MM SSS ₹ 154



OZ-BH-NBB-E
5x2.5x2.5MM SSS ₹ 200

TELESCOPIC SLIDING DOOR SYSTEMS FOR WOODEN AND FRAMED DOORS



Ozone introduces the Wooden Synchronized Manual Telescopic Sliding Door System to achieve Maximum clear door opening. Door panels can be stacked on one side in-line with the top track and require minimal parking space.

Its ideal applications are in residential and commercial interior spaces as internal partitioning system. For more details, send an enquiry at support@ozone-india.com.

Specifications:

- Maximum Width of Panels: 1000mm
- Maximum Weight of Panels: 90Kg
- Maximum Thickness of Panels: 35mm
- Available Track length: 3mtr & 4mtr
- Finish: Aluminum Anodized

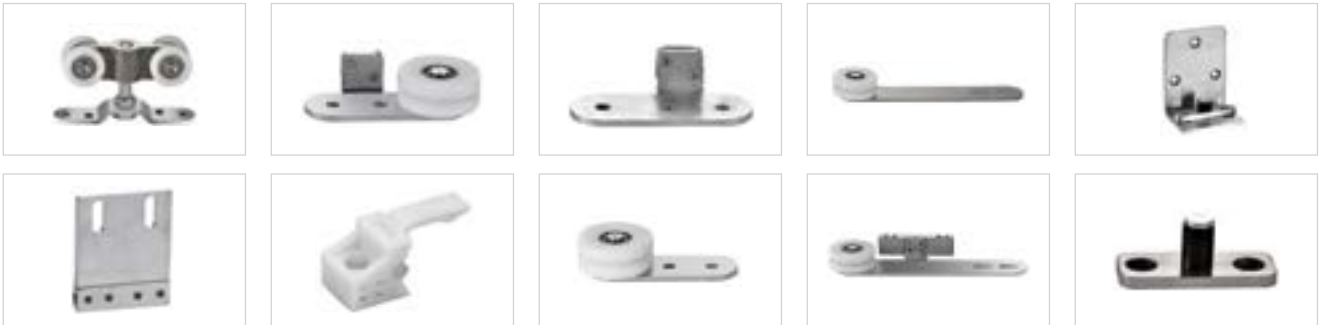

3 PANEL DOOR SLIDING SET:

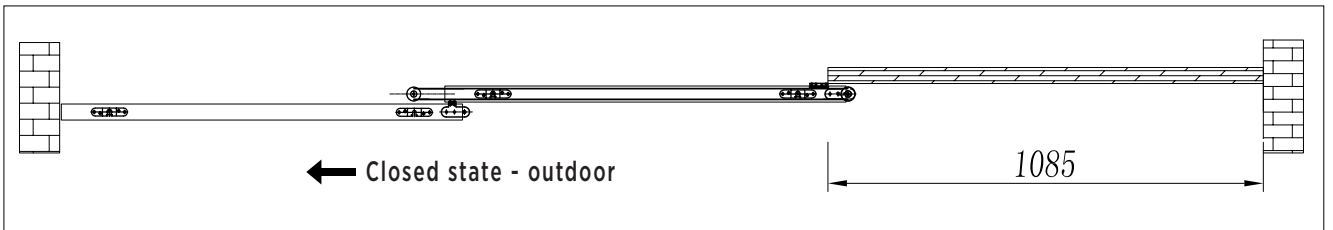

OSL-TW-03 R Std AN ₹ 22,984

Right Hand Opening

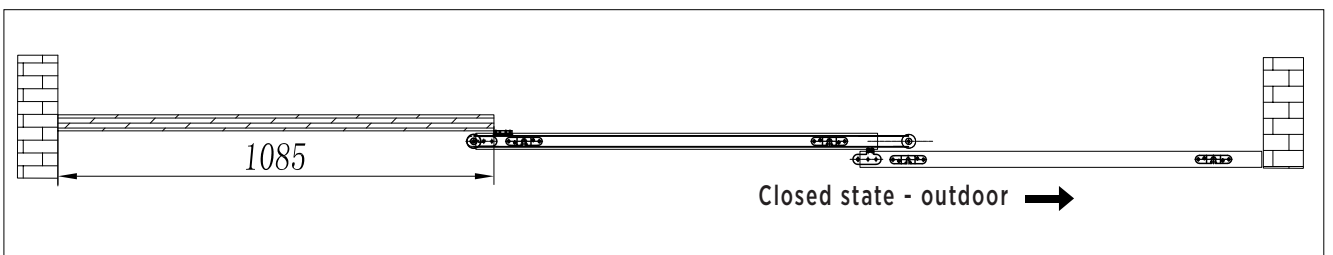

OSL-TW-03 L Std AN ₹ 22,984

Left Hand Opening

TELESCOPIC SLIDING DOOR SYSTEMS FOR WOODEN AND FRAMED DOORS

4 PANEL DOOR SLIDING SET:

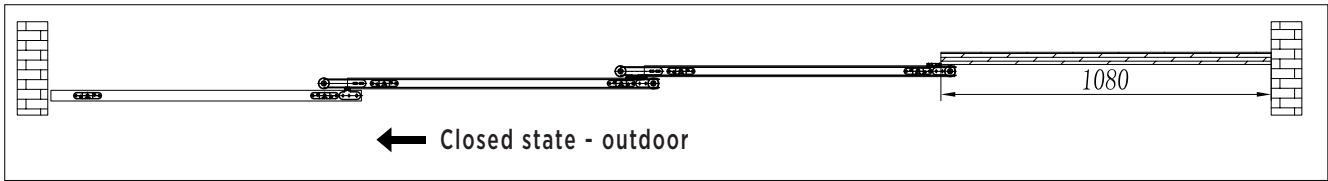

OSL-TW-04 R Std AN ₹ 36,448

Right Hand Opening

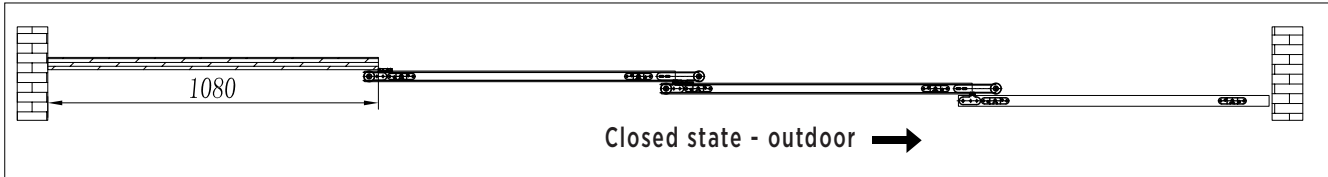



OSL-TW-04 L Std AN ₹ 36,448



Left Hand Opening

TOP TRACK & ACCESSORIES

Top Track & Accessories For 3 Panels (OSL-TG-3R/3L)

<p>OSL-TW-Track-ACC-3mtr AN ₹ 28,314 3mtr Track with other Accessories</p>	<p>OSL-TW-Track-ACC-4mtr AN ₹ 38,823 4mtr Track with other Accessories</p>
 Top Track-2Pcs.	 Pelmet Cover-2Pcs.
 SS Rope, 2.3mtr-1Pc.	

Top Track & Accessories For 4 Panels (OSL-TG-4R/4L)

<p>OSL-TW-Track-ACC-3mtr AN ₹ 28,314 3mtr Track with other Accessories</p>	<p>OSL-TW-Track-ACC-4mtr AN ₹ 38,823 4mtr Track with other Accessories</p>
 Top Track-2Pcs.	 Pelmet Cover-2Pcs.
 SS Rope, 2.3mtr-1Pc.	

Additional Accessories Required For 4 Panels

OSL-TGW-Track-3mtr AN for 3mtr ₹ 9,211

(Bottom U channel 1pc)

OR

OSL-TGW-Track-4mtr AN for 4mtr ₹ 12,240

(Bottom U channel 1pc)



OSL-TGW-Rope-2mtr SS ₹ 817

(SS Rope 2.3 mtr 1pc)



ALSO AVAILABLE FOR
GLASS DOORS

SLIDING FOLDING SYSTEM - 555 FOR FRAMED/WOODEN DOORS



Ozone offers Sliding Folding Partitioning System for wood & framed door panels in different panel configurations. This system is a combination of various stainless steel fittings to enable achieving desired partitioning width and smooth sliding folding movement of the panels. Our technical team can help you to create customized options.

Features:

- SS Hinges SS-304
- Aluminium top & bottom with anodized finish
- Nylon hanger/roller

Specifications:

- Maximum opening: 8mtr
- Maximum panel weight: 80kg
- Maximum panel height: 3000mm
- Maximum panel width: 1000mm
- Min panel thickness: 35mm



Scan QR for
Installation Video

FITTINGS (Images only for reference)



Note:- For ordering purpose refer the table on next page.

Product Kit Components:

How to Order						
	SL-WSFS-555-2 2 Panel Sliding Folding set	SL-WSFS-555-3 3 Panel Sliding Folding set	SL-WSFS-555-4 4 Panel Sliding Folding set	SL-WSFS-555-5 5 Panel Sliding Folding set	SL-WSFS-555-6 6 Panel Sliding Folding set	SL-WSFS-555-8 8 Panel Sliding Folding set
SL-WSFS-555 WOOD FOLD SYSTEM	2 panel 	3 panel 	4 panel 	5 panel 	6 panel 	8 panel
MRP (₹)	₹ 38,576	₹ 53,782	₹ 70,721	₹ 84,940	₹ 10,0642	₹ 13,0933
Pivot set (A) 	1 Set	1 Set	1 Set	1 Set	1 Set	1 Set
Offset hinge set (B) 	-	1 Set	2 Set	1 Set	2 Set	2 Set
Center hinge set (C) 	1 Set	-	1 Set	1 Set	1 Set	2 Set
Intermediate carrier set (D) 	-	1 Set	1 Set	2 Set	2 set	3 Set
Right/ Left carrier set (E) 	1 Set	-	1 Set	-	1 Set	1 Set
Drop bolt (F) 	1 No.	1 No.	2 Nos.	2 Nos.	3 Nos.	4 Nos.
 TOP TRACK-2M BOTTOM TRACK-2M	1 Set	-	2 Set	1 Set	-	-
 TOP TRACK-3M BOTTOM TRACK-3M	-	1 Set	-	1 Set	2 Set	-
 TOP TRACK-4M BOTTOM TRACK-4M	-	-	-	-	-	2 Set

PREMIUM MANUAL SLIDING SYSTEMS

S Series
Premium Collection of
Architectural Hardware

Heavy duty **80-150kg** also available



Item Codes:

- OZSL-P-S-SYS STD SSS ₹ 33,184
- OZSL-P-S-Track 2mtr SSS ₹ 20,401



Soft Close

Key Features:

- Soft closing single sliding wooden door
- Suitable for office, kitchen, living room, and pocket doors
- Elegant and slim design
- Can be mounted on glass, wall, and ceiling
- Internationally patented in Germany as per EN1527 standards
- Roller tested for 100,000 cycles
- Hydraulic soft closing bumper-Tested for 2,00,000 impact cycles
- Energy efficient-prevents AC loss by allowing minimum 5mm gap between sliding & fixed glass
- Adjustable soft closing pulling force for different door weight 40-80kg

Specifications:

- Slim Track Size: 54x58mm
- Door height adjustment +/-3.5mm on carriage and prevent the de-railing of sliding door
- Maximum door weight: 40-80kg / 2 carriages
- Aluminium anodised top track
- Finish: SS or brushed clear
- Length: 2mtr (Standard) and 4mtr (Against order)

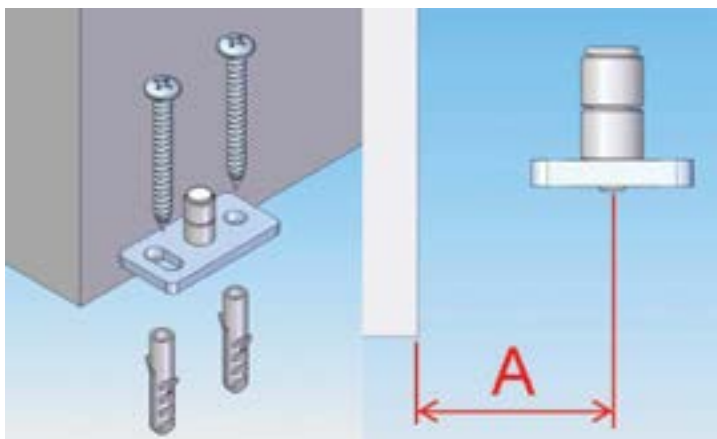

OZ-SD-754 (Floor Guide)

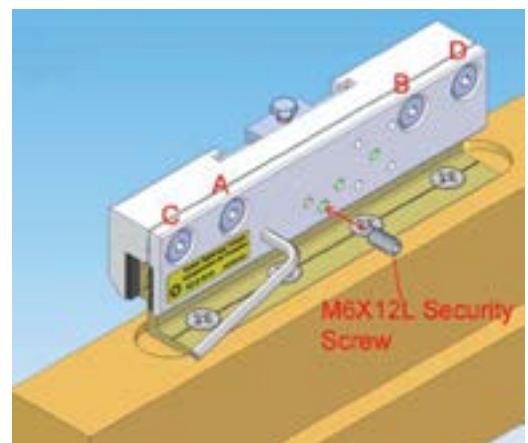

OZ-LYON-101 (Wooden Clamp)

INVISIBLE SLIDING SYSTEM

OZ-SL-INV-SYS-80 1.22 mtr Std ₹ 38,054



Features:

- Partially door opening : 650-1070mm
- Concealed rail partition door
- 80Kg loading capacity, not easy to deform
- Anti fall off sliding door system
- Doorway width : 533-935mm (door fully open)
- Removable dampener positioning
- Flexible adjustment, easy & convenient
- Elegant design, smooth & silent
- Easy installation

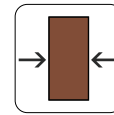

Door Width
800-1220mm



Weight Carrying
Capacity

Fitting Details:

Description	Top Roller	Soft Close Damper	Side Roller	Floor Guide
Product Image				
Qty.	1	2	2	1

Description	Bottom Roller	End Cap	Top Rail	Bottom Rail
Product Image				
Qty.	2	1	1	1

*Available on request

SLIDING SYSTEM FOR WOODEN/FRAMED DOORS



OZ-ESL-WD-11-80 ₹ 1,482
Sliding System Set W/O Track for Single Framed/Wooden Door of **80kg**



OZ-ESL-WD-11-100 ₹ 2,189
Sliding System Set W/O Track for Single Framed/Wooden Door of **100kg**



OZ-ESL-TRACK-E2 ₹ 2,347
Top Track Suitable for ESL-WD-11-80 and WD-11-100 (Available in 2mtr & 4mtr)

SLIDING SYSTEM FOR WOODEN/FRAMED DOORS FOR HOTEL BATHROOMS



OZ-ESL-WD-22-140 ₹ 4,806
Framed/Wooden Sliding Door System W/O Track for 140kg Door (Available with Side Wall-to-track Holder)



OZ-ESL-TRACK-E3-A1 ₹ 338
OZ-ESL-TRACK-E3-A2 ₹ 682
Wall-to-track Connector



OZ-ESL-TRACK-E3 1Mtrs STD ₹ 1,769
Top Track Suitable for ESL-WD-22-140 Available in 2mtr & 4mtr Length

SOFT CLOSE SLIDING SYSTEM FOR FRAMED/WOODEN DOORS



OZ-ESL-WD-44-SC-N STD STD ₹ 6,141
Soft Close Sliding System with Accessories
for Framed/Wooden Door (Single Door) W/O Track
Maximum Door Weight: 60kg/Door



OZ-ESL-TRACK-E5-N 2mtr STD ₹ 3,938
OZ-ESL-TRACK-E5-N 4mtr STD ₹ 8,059
Top Track Available in 2mtr & 4mtr



OZ-ESL-FG-BT 2 mtrs STD ₹ 1,135
Bottom Track

HANDLES FOR WOODEN SLIDING DOORS



SL-WD-HN-10 ₹ 815
Sliding Door Handle for
Wooden Door



OZ-ESL-WD-ACC-11 STD PSS ₹ 4,472
Lock and Handle for
Wooden Sliding Door



OZ-ESL-WD-ACC-22N ₹ 2,603
Mortise Sliding Door Lock